

Catalog **2008**



**PVLED**

**DC Lighting**

**Innovative Solar street Light Solution**

**Solar street Lighting Component**

[www.pvled.com](http://www.pvled.com)

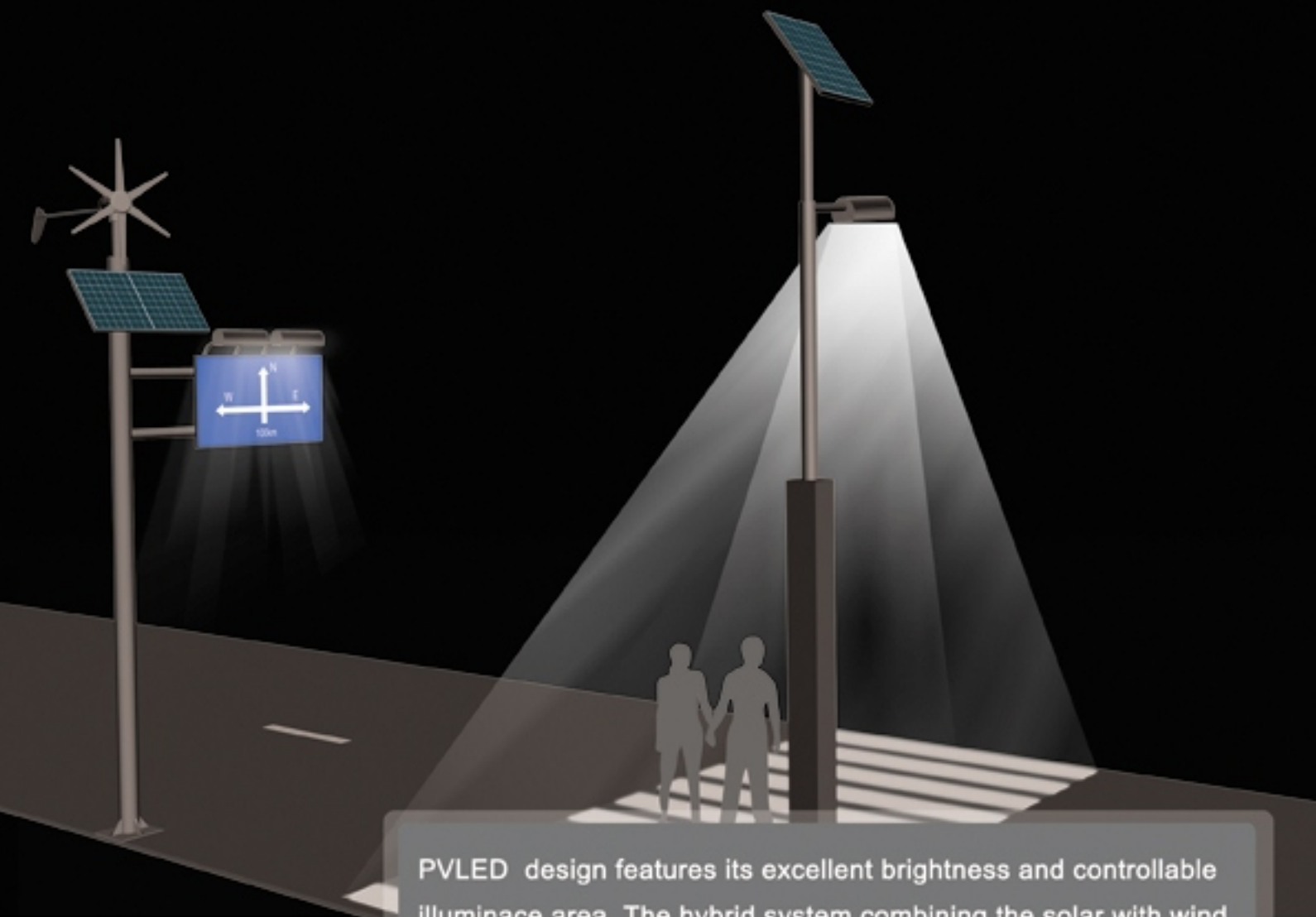

PVLED design features its excellent brightness and controllable illuminance area. The hybrid system combining the solar with wind turbine ensures the maximum power output during the adverse weather conditions. PVLED is flexible enough to control the lighting area, so it is very suitable for the lighting of zebra crossings, billboards, etc.

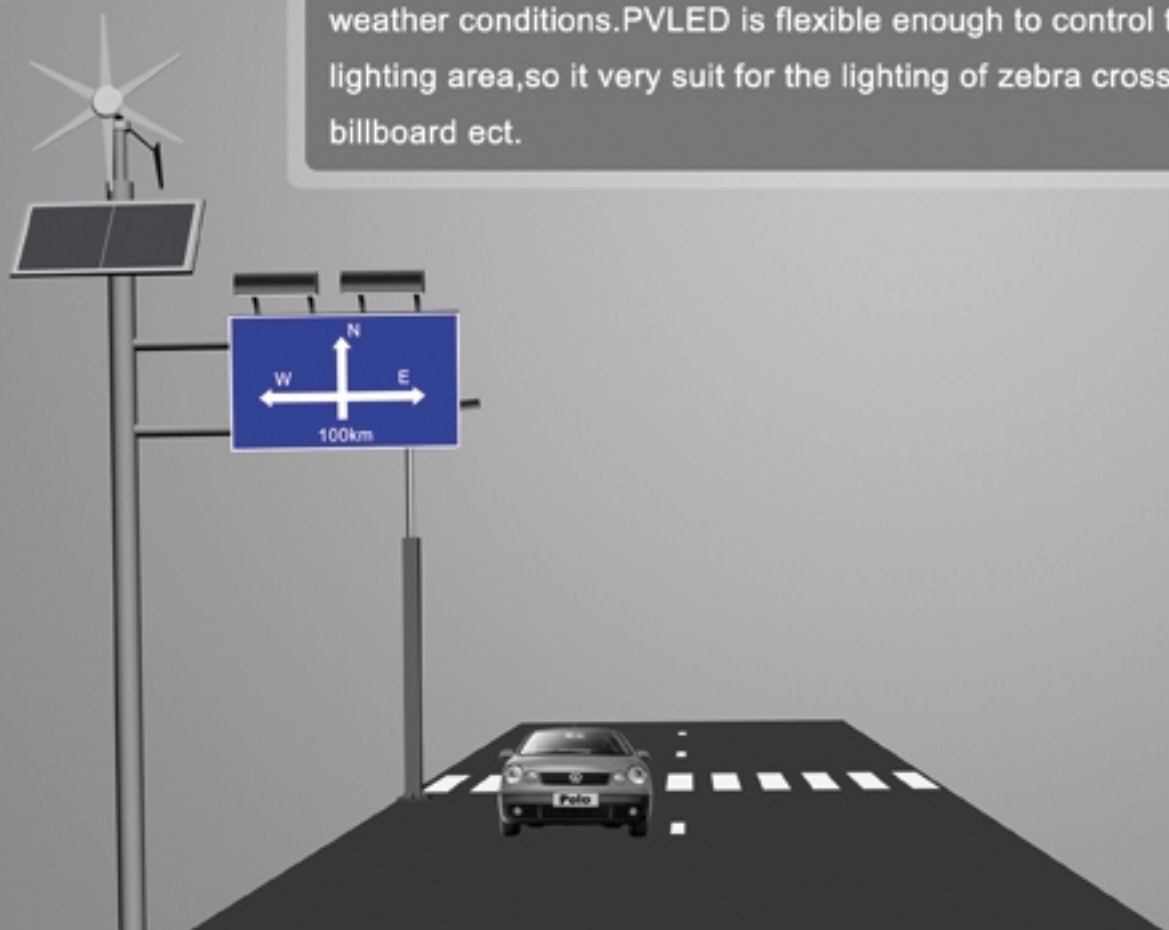

# New Reflector design for outdoor application

Patent Number: JP2006-023842

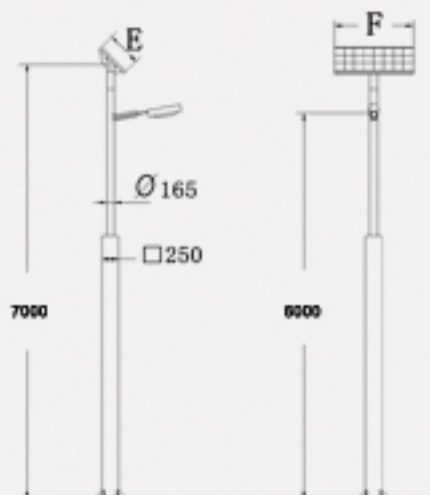
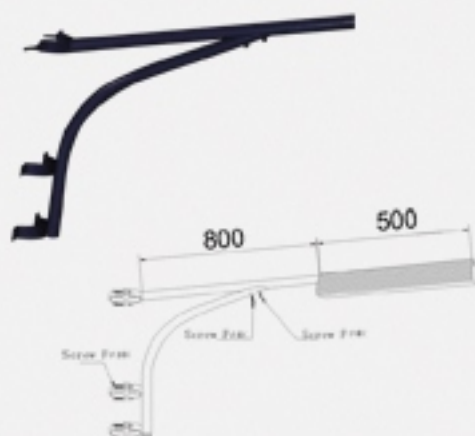
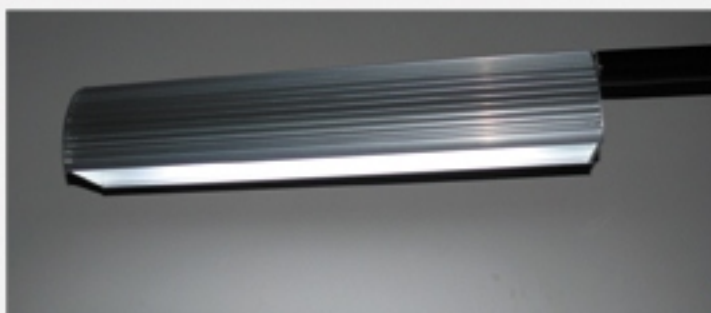
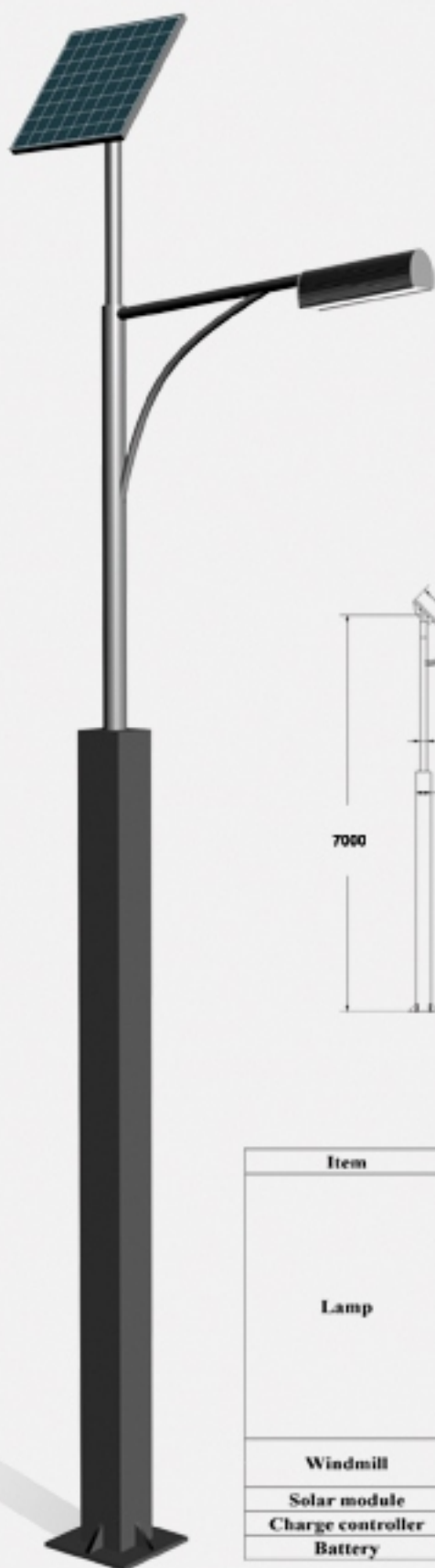

Luminance of LED solar street light  
PVL-LT-HPLED20W

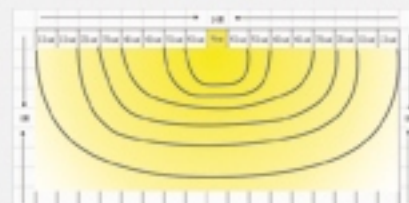

Item	Parameter	Parameter		
		PVL-LT-HPLED20	PVL-LT-HPLED30	PVL-LT-HPLED40
Lamp	Rated power	20W	30W	40W
	Rated voltage	12V	12V	12V
	Input voltage	DC12V-14V	DC12V-14V	DC12V-14V
	Current	1.6A	2.5A	3.3A
	Installation height	4-6m	6-8m	6-8m
	Hi-power LED	>1000lm	>1500lm	>2000lm
	Light color	6000K	6000K	6000K
	Lifespan	30,000hrs	30,000hrs	30,000hrs
	Dimension	50 × 12 × 12.8cm	50 × 12 × 12.8cm	65 × 12 × 12.8cm
	Weight	3.7kg	3.7kg	4.7kg
Windmill	Size	12V	12V	12V
	Anemometer	3.9-5.7m/s	9-12m/s	9-12m/s
Solar module	Optional	40-60W/17.3V	60-80W/17.3V	80-160W/17.3V
Charge controller	Optional	12V/10A	12V/10A	12V/10A
Battery	Optional	75AH/12V	100AH/12V	100AH/12V

# Hybrid solar+wind for street light

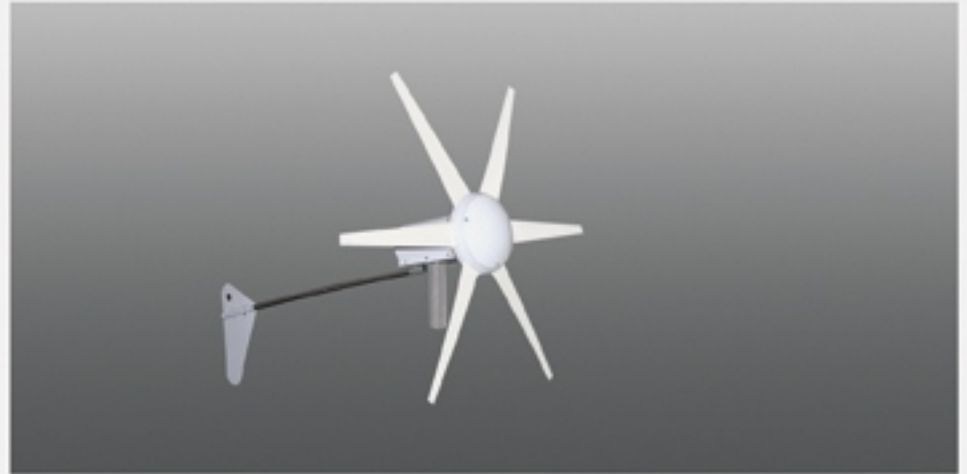

Maximum power(w)	300	Rated RPM	100-500
Rated wind speed(m/s)	7-8	Battery regulator(V)	12
Cut in wind speed(m/s)	3	Tower height(M)	6-10
Rotor diameter(m)	1.1	Standard tower	6.5m guyed wire
Number of blades	6	Weight(KG)	12



MODEL	PMAX	IPM	VPM	ISC	VOC	SIZE	WEIGHT
PVL-CIS-2.5W	2.5W	0.31A	8.06V	0.37A	11.85V	256*192*33.8mm	1kg
PVL-CIS-5W	5W	0.29A	17.3V	0.39A	24.2V	256*322*33.8mm	1.5 kg
PVL-CIS-10W	10W	0.58A	17.3V	0.76A	24.2V	458*322*33.8mm	2.5 kg
PVL-CIS-20W	20W	1.17A	17.3V	1.52A	24.2V	458*590*33.8mm	4.3 kg
PVL-CIS-30W	30W	1.73A	17.3V	2.29A	24.2V	660*590*33.8mm	6.7 kg
PVL-CIS-40W	40W	2.31A	17.3V	3.06A	24.2V	862*590*33.8mm	7.8 kg
PVL-CIS-50W	50W	2.90A	17.3V	3.84A	24.2V	1064*590*33.8mm	9.6 kg
PVL-CIS-60W	60W	3.5A	17.3V	4.6A	24.2V	862*858*33.8mm	11.1 kg
PVL-CIS-80W	80W	4.85A	17.3V	5.8A	24.2V	862*1126*33.8mm	14.4 kg
PVL-CIS-100W	100W	6.06A	17.3V	7.25A	24.2V	1064*1126*33.8mm	18.8 kg
PVL-CIS-120W	120W	7.3A	17.3V	9A	24.2V	1266*1126*48mm	22.1 kg

# Low Pressure Sodium Lamp

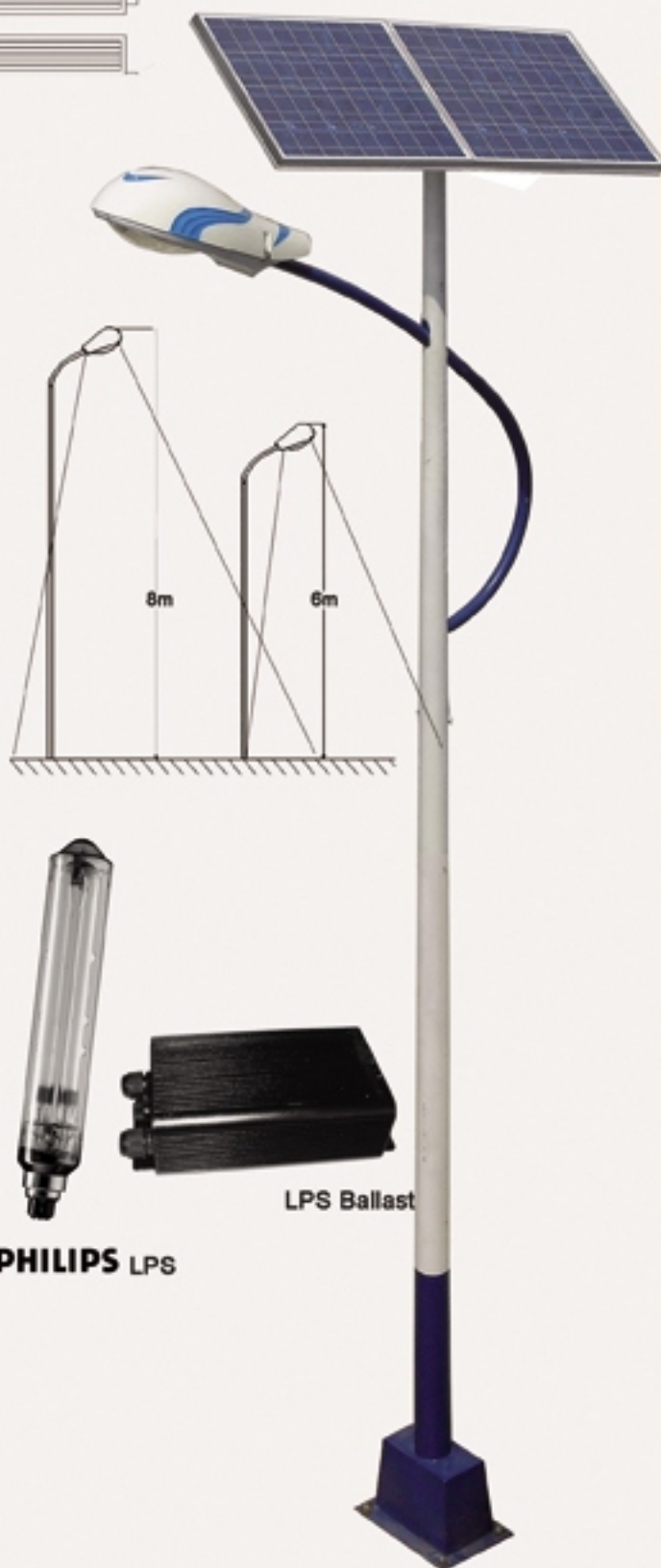
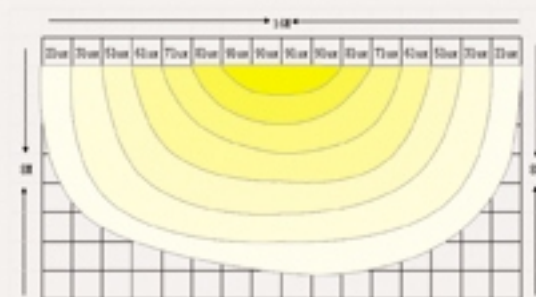
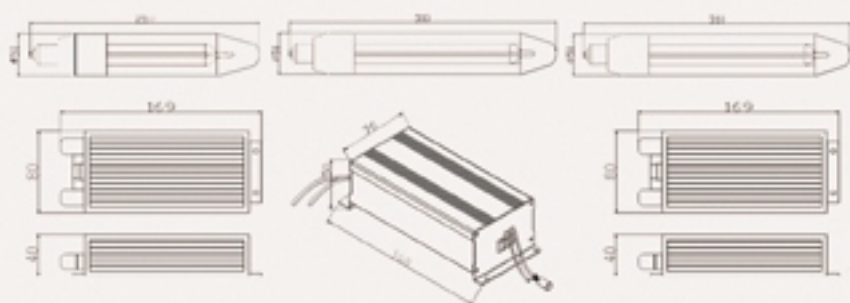

Model	PVL-LT-LPS150	PVL-LT-LPS250	PVL-LT-LPS350
Normal power	15W	25W	35W
Normal voltage	12V	12V	12V
Input voltage	DC10V-14V	DC10V-14V	DC10V-14V
Current	1.5A	2.17A	3A
Installation height	4m-6m	4m-6m	6m-8m
Philips LPS			
Light color	2800K	2800K	2800K
Lifespan	20,000H	20,000H	20,000H
Dimension	51*120mm	51*310mm	51*310mm
Weight	145g	215g	215g
Ballast			
Ambient temperature	-30℃~+50℃	-30℃~+50℃	-30℃~+50℃
Dimension	169*80*40mm	168*78*50mm	169*80*40mm
Weight	700g	540g	700g
Recommended			
Solar module	40W-60W/17.3V	60W-80W/17.3V	80W-160W/17.3V
charge controller	12V/5A	12V/10A	12V/10A
Battery	50AH-75AH/12V	75AH-100AH/12V	80AH-150AH/12V

PHILIPS LPS

LPS Ballast

# LED Street Lamp

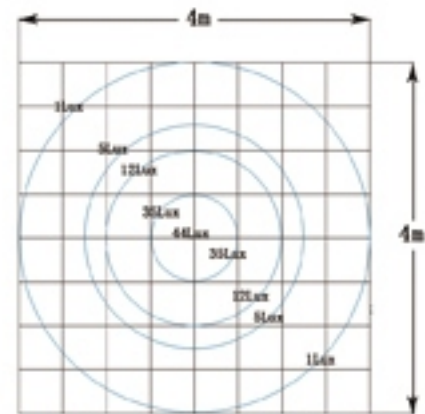
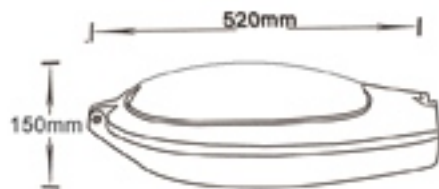

Luminance of PVL-LT-LED150

Easy Installation

Maintenance Free

--No bulb replacement during the lifetime

Over charge and over discharge protection

Optional controller

--turn on and turn off automatically









Timer controller

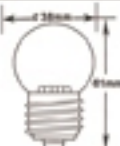

--2H,4H, 6H, 8H,10H... optional

Model	PVL-LT-LED100	PVL-LT-LED150	PVL-LT-LED200
Solar module(recommended)	20W-30W/17.3V	40W-50W/17.3V	60W-80W/17.3V
Battery(recommended)	24AH-38AH/12V	50AH-75AH/12V	80AH-100AH/12V
Normal power	10W	15W	20W
Normal voltage	DC12V-14V	DC12V-14V	DC12V-14V
Lifespan	50,000H	50,000H	50,000H
Ambient temperature	-40 ℃~+70℃	-40 ℃~+70℃	-40 ℃~+70℃
Light color	6000k cool white	6000k cool white	6000k cool white
LED	200pcs	280pcs	360pcs
Over charge protection	14.1V	14.1V	14.1V
Over discharge protection	10.8V	10.8V	10.8V
Timer controller	2,4,6,8...hours optional	2,4,6,8...hours optional	2,4,6,8...hours optional
Star darkness automatically	Less than 120 LUX	Less than 120 LUX	Less than 120 LUX
Dimension	520*200*230mm	520*200*230mm	520*200*230mm
Weight	1800g	2000g	2200g
Packing	1pcs/carton	1pcs/carton	1pcs/carton

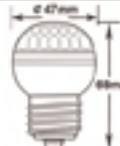
Select the solar panel according to local weather and lighting time request.

## DC12V LED Lamp





Model	PVL-LED004	PVL-LED008	PVL-LED010	PVL-LED010B
				
Normal power	0.4W @13V	0.8W @13V	1W @13V	1W @12V
LED	8pcs	16pcs	20pcs	20pcs
Weight	22g	30g	40g	58g
				

	PVL-LED016	PVL-LED012	PVL-LED018	PVL-LED030
				
Model	1.6W @13V	1.2W @13V	1.8W @13V	3.0W @13V
Normal power	32pcs	24pcs	36pcs	60pcs
LED	41.5g	160g	185g	195g
Weight				

## DC12V CFL Lamp

PREHEATING CFL LAMP  
HIGH ELECTRONIC EFFICIENCY  
LOW THERMAL LOSS



Model	PVL-CFL050A	PVL-CFL070A	PVL-CFL090A	PVL-CFL110A
Normal power	5W	7W	9W	11W
Normal voltage	DC12V-14V	DC12V-14V	DC12V-14V	DC12V-14V
Lifespan	6,000H~8,000H	6,000H~8,000H	6,000H~8,000H	6,000H~8,000H
Ambient temperature	-5℃~+40℃	-5℃~+40℃	-5℃~+40℃	-5℃~+40℃
Weight	98g	100g	102g	104g
				



PVLED Technology

Factory Add: Post Building, Lantian Industrial Zone, Zhangzhou city, Fujian, China

Tel: +86-596-2106379 / 2105878 Fax: 86-596-2130179

Xiamen office:

No.152, Tiancuo Road, Siming District, Xiamen city, Fujian, China

Tel: 86-592-5900587 Fax: 86-592-5021417

Taiwan office: Tel: +886-952-646968 Fax: +886-5-2768775

5F-1, No.32, An-Ler, Street, Chia-Yi City, Taiwan

E-mail: [pang@pvled.com](mailto:pang@pvled.com)

[Http://www.pvled.com](http://www.pvled.com)